

# Timesavers 32-Series-RB – Rotary Brush Machine

Preslefuirea, rotunjirea muchiilor, si finisarea suprafetelor intr-o singura trecere

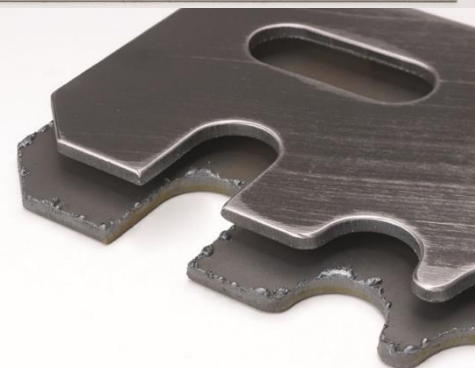

# Debavurare si rotunjire egala a muchiiilor cu perii abrazive

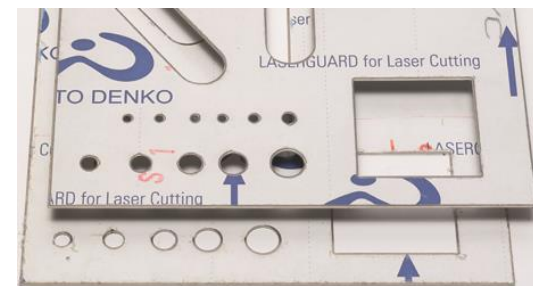
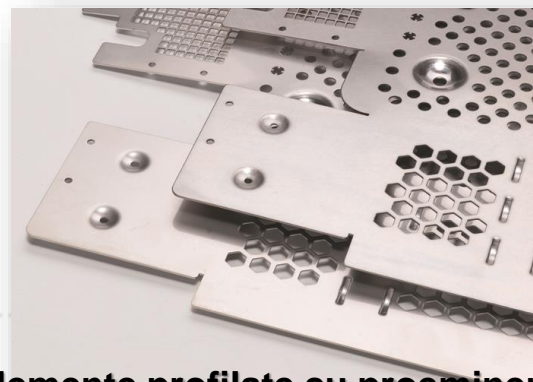
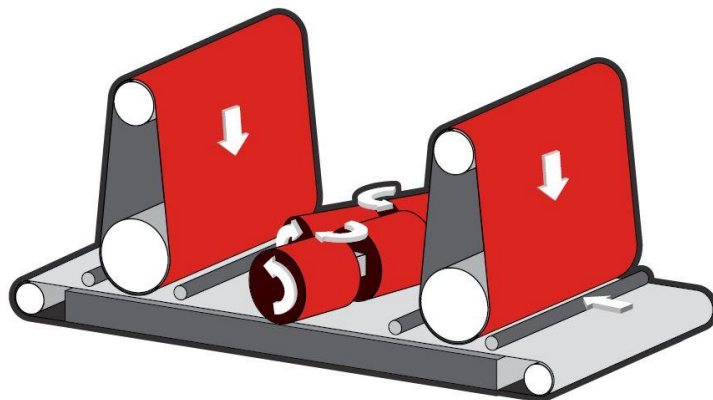
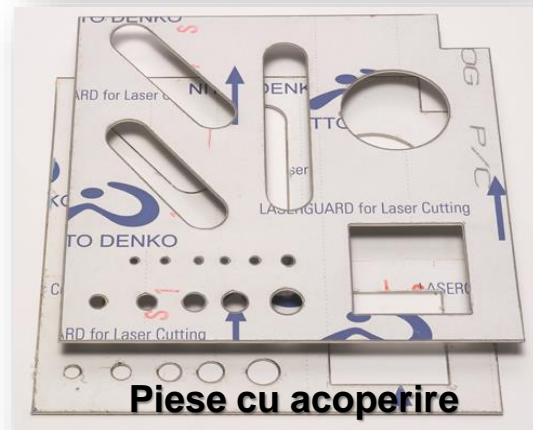
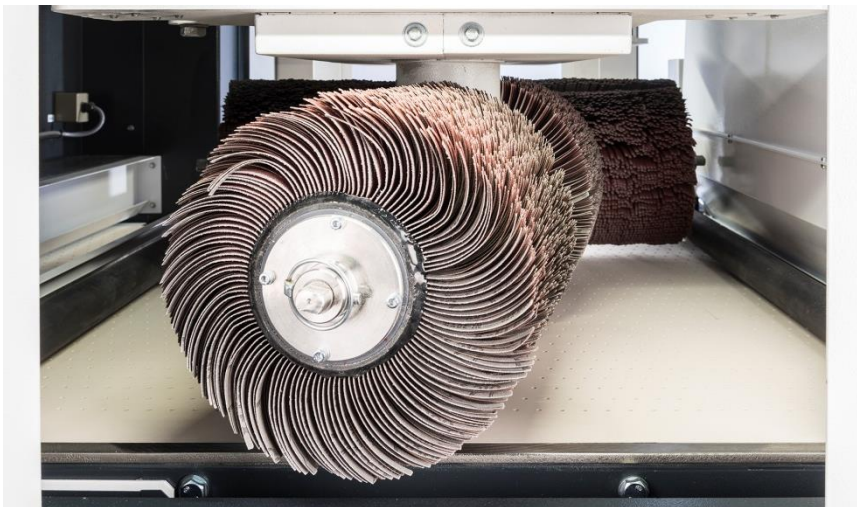

**Preslefuire cu benzi abrazive , debavurare si rotunjire  
egala a muchilor cu perii abrazive**

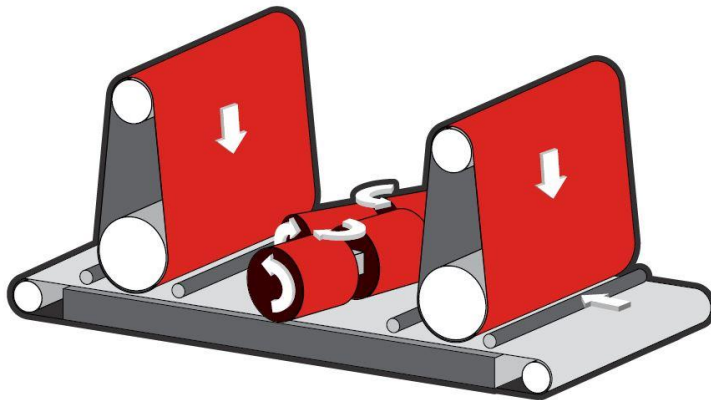
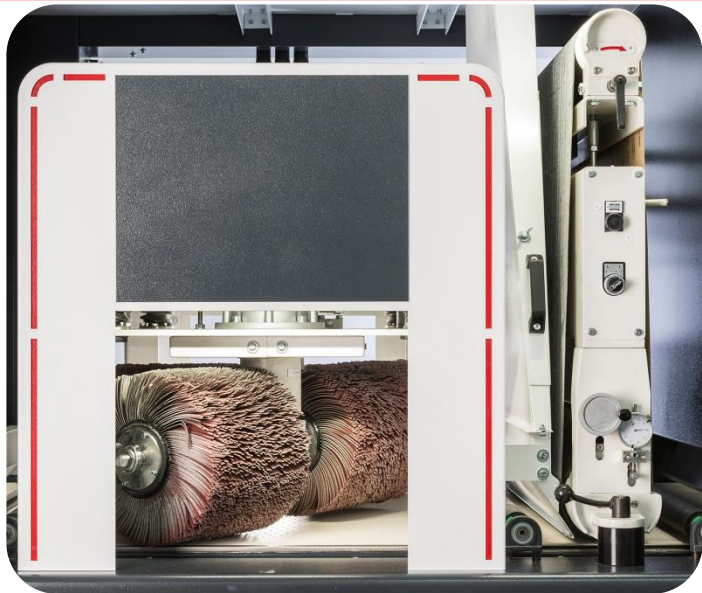

**Piese taiate cu Plasma**

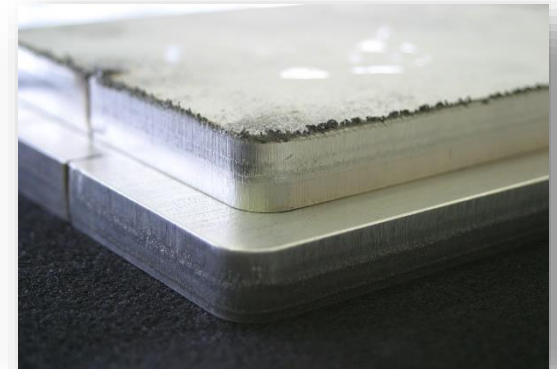

**Piese taiate cu Laser**

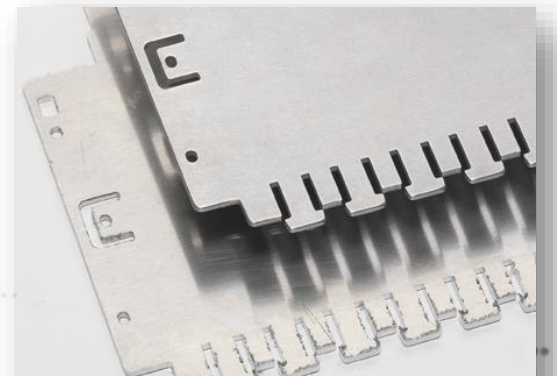

**Piese Aluminiu taiate cu Laser**

Preslefuire cu benzi abrazive, debavurare si rotunjire egala a muchilor cu perii abrazive si finisarea suprafetei cu benzi din panza nețesută (gen Scotch Bright® )

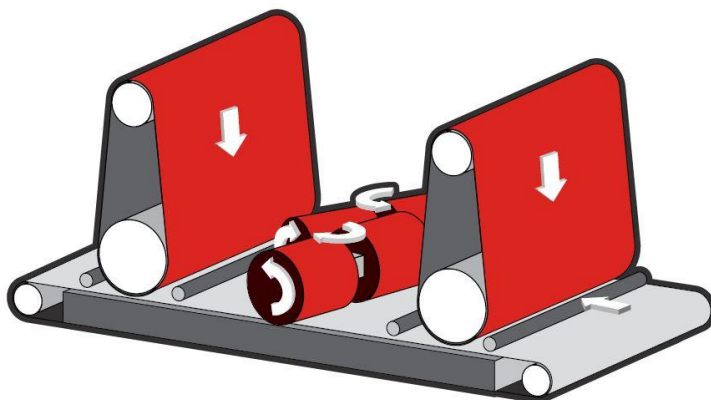
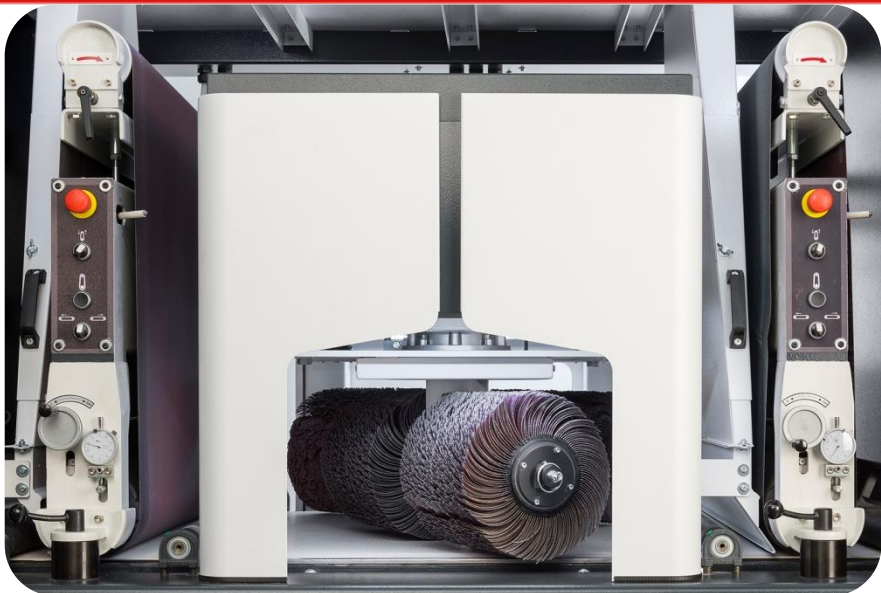

# Indeprtarea bavurilor taierii laser-oxi cu perii de sarma

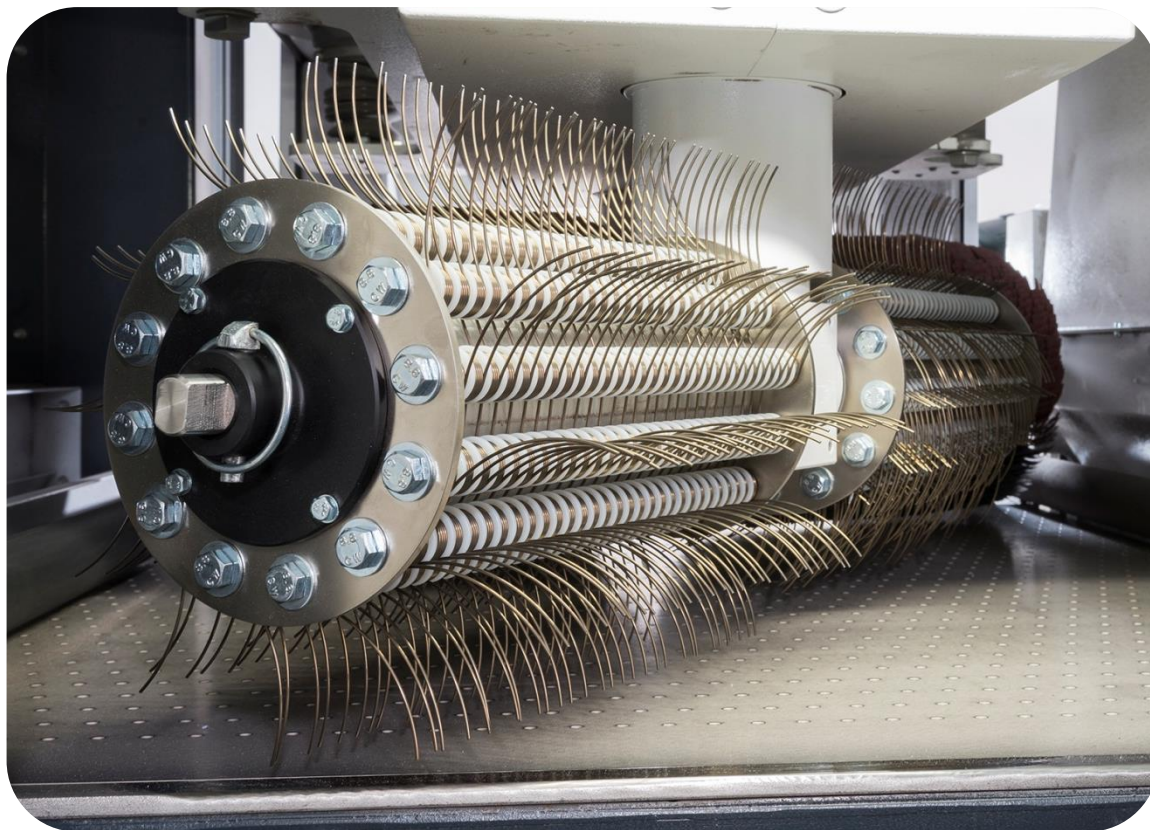

**INAINTE**

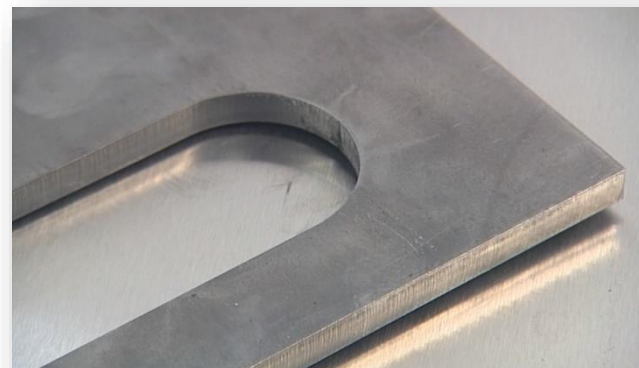

**DUPA**

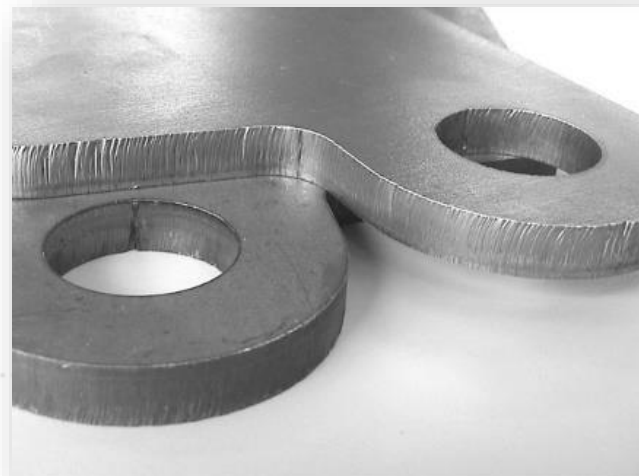

# CARACTERISTICI

- Design nou, fara suruburi si piulite vizibile si acces facil pentru schimbarea rapida a sculei si pentru operatia de curatare
- Schimbare rapida a sculelor, ceea ce duce la scurtarea timpului procesarii materialelor diferite
- Posibilitatea procesarii materialelor diverse, daca se utilizeaza un aspirator adecvat de praf umed
- imbunatatirea controlului procesului cu noul panou de operare la 45 de grade.
- Usi transparente si interiorul masinii iluminat pentru a controla procesul
- Masa cu vacuum si bandă transportoare cu aderență ridicată pentru a putea procesa piese mici de la 50 x 50 mm
- Ciclu de curatare automata pentru interiorul mesei de aspiratie la oprirea masinii
- Bare LED pe partea de alimentare care indica starea masinii
  - Rosu → oprire de urgenta
  - Albastru → masina este in Standby
  - Verde → masina este in functiune

Barele LED pe partea de alimentare si de iesire indica starea masinii



Operare intuitiva  
Panou de comanda la un unghi de 45 de  
grade





# Capul periei rotative

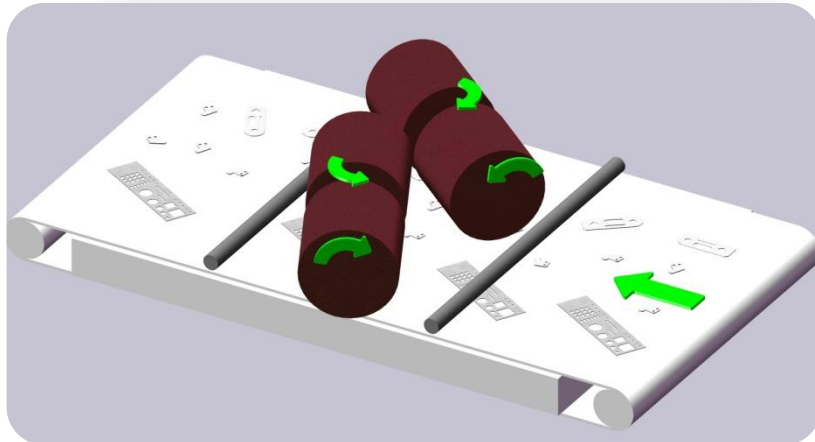
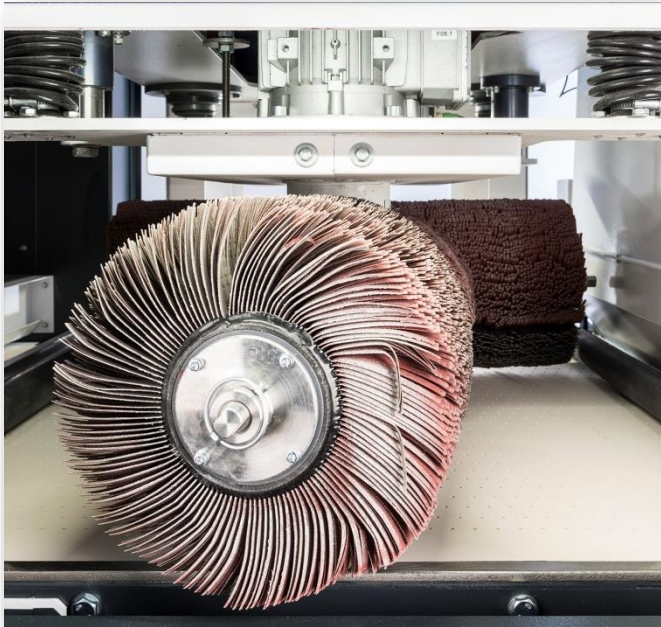

- Capul periei cu 2x2 (4) perii abrazive rotative in contrasens
- Procesarea cu o setarea unica a grosimilor diferite ale piesei
- Durată lungă de viață a periei, aprox 2000 ore
- Perii cu sistem de schimbare rapida  
Schimbarea periiilor in 10 min.
- Controlul prin frecventa a vitezei periei
- Reglarea mecanizata a capului
- Masa standard cu vacuum pentru fixarea pieselor mici de la 50 x 50 mm
- Grosimi ale produselor pana la 100 mm
- Controlul prin frecventa a vitezei de alimentare 0,2-8 m/min

# Timesavers RB – Schimbarea periiilor



1

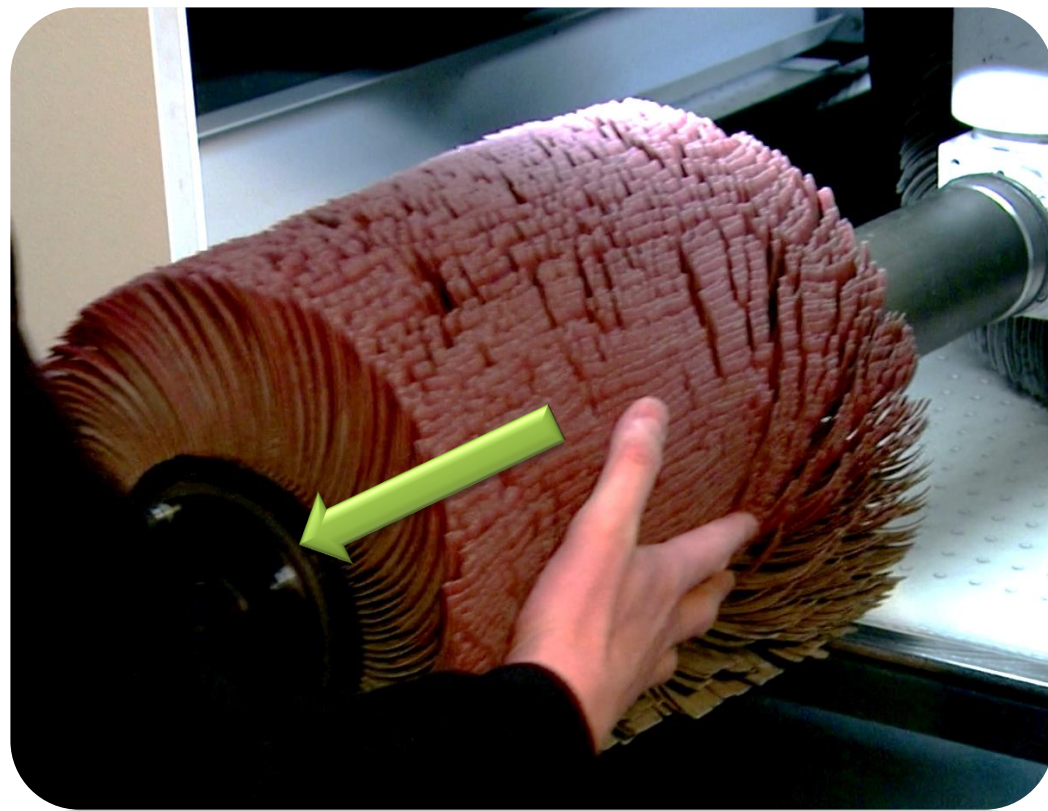

2

# Timesavers RB – Rotary Brush Machine

Masina cu unitate de exhaustare



# Timesavers RB – Rotary Brush Machine



Optiune: transportor cu intoarcere la 180 grade

# Timesavers RB – Rotary Brush Machine

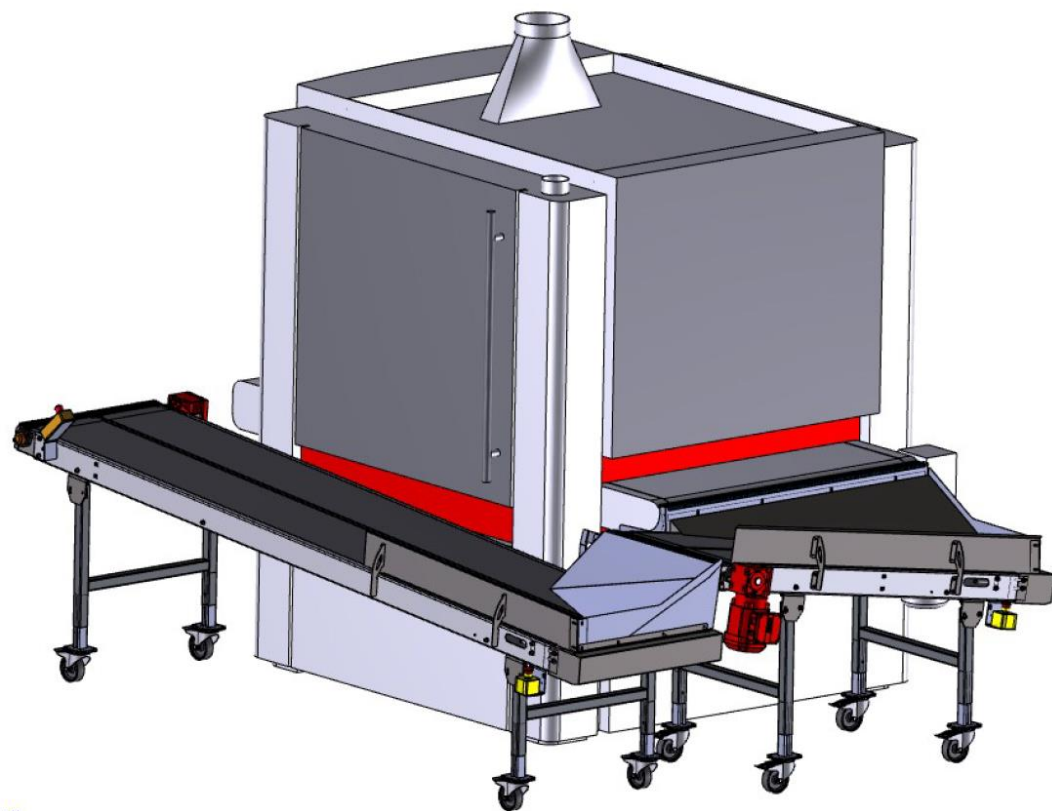

Optiune : Transportor cu intoarcere

# Timesavers RB – Rotary Brush Machine

**Optiune :  
Masa din spate extinsa**

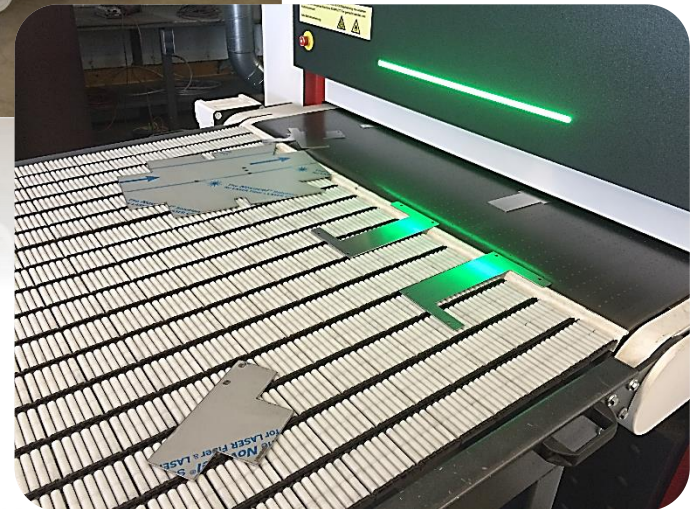

# Timesavers RB – Rotary Brush Machine



Optiune: Camera in partea de iesire a masinii

# Timesavers RB – Timesavers RB – Rotary Brush Machine : curatarea produsului

## Perie Wandres de curatare a produselor pentru componentele dulapurilor electrice

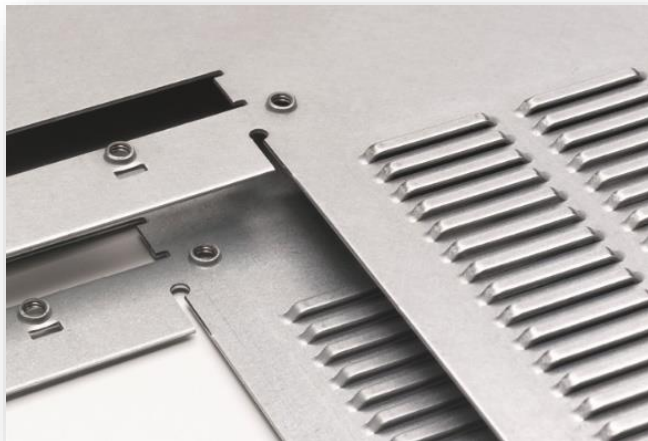



# Reglarea automata a vacuumului si curatarea mesei de vacuum



**Automatic vacuum regulation  
with frequency controller**

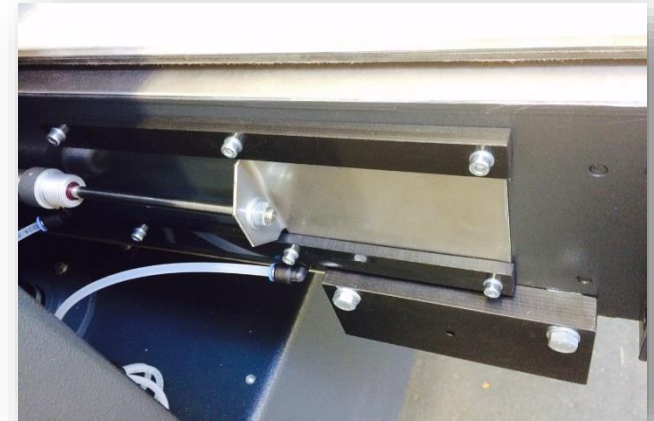

**Curatarea automata a mesei de vacuum. Ecranele de curatare se deschid automat atunci cand masina se opreste sau cel tarziu dupa 4 ore de prelucrare.**

# Timesavers RB – Rotary Brush Machine

## Durata de viata a sculelor la 42-Series depaseste 3000 ore

Timpul de funcționare cca. 1600 ore / An

Procesare 800 tone / an oțel inoxidabil prelucrat cu Laser: 1, 1,5, 2 și 3 mm

Punerea în funcțiune a 2 mașini în august / sept 2009 (viteza de periere circa 50%)

		MOBA	
punkt		Haarenlänge	Stunden
1	September-09	92	0
2	oktober 09	89	300
3	November-09	85	600
4	February-10	80	930
5	March-10	75	1070
6	April-10	71	1200
7	May-10	68	1430
8	July-10	65	1650
9	September-10	60	1920
10	October-10	58	2080
11	December-10	54	2330
12	januari 2011	50	2450
13	Februari 2011	46	2680
14	March-11	41	2810
15	April-11	36	2930
16	May-11	32	3044

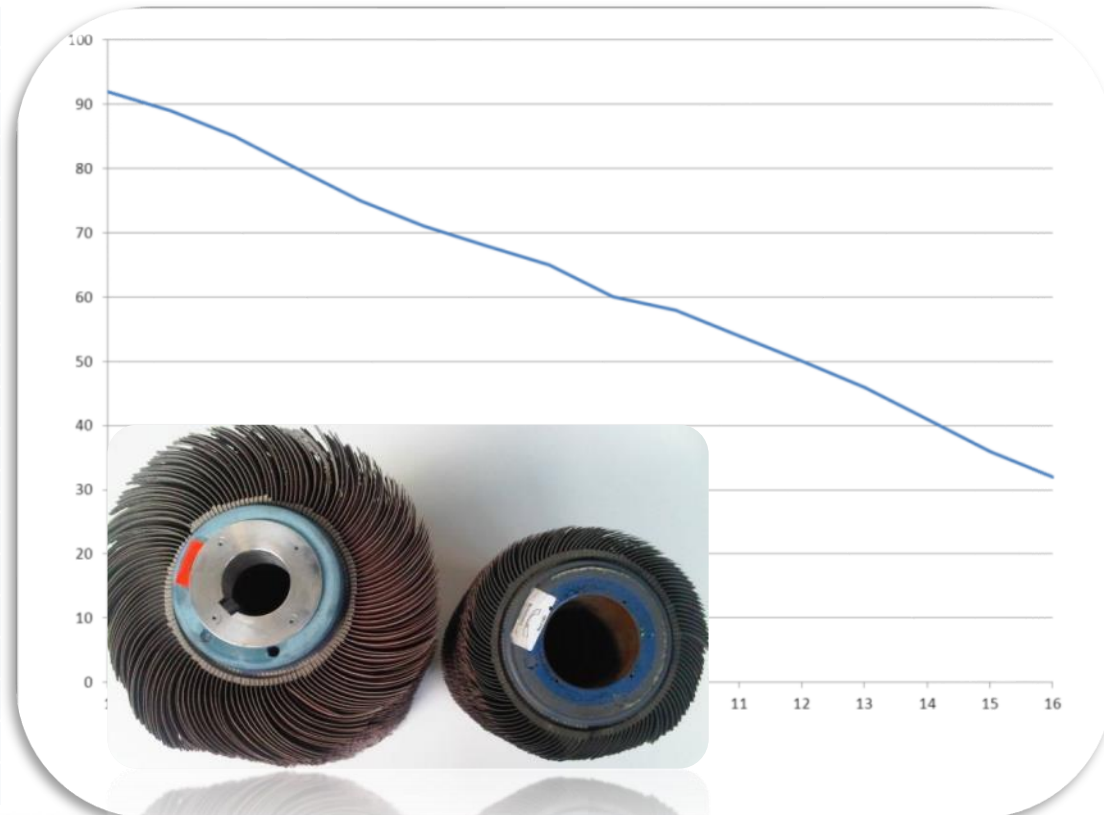



VĂNZĂRI ȘI SERVICE ÎN ROMÂNIA

**AGO TRADE  
INTERNATIONAL SRL**

Str.Toamnei, 75, 020403

Sector 2 – București

021 250 15 04

[sales@a-g-o.com](mailto:sales@a-g-o.com)

[www.a-g-o.com](http://www.a-g-o.com)



**Timesavers International B.V.**  
Fruitlaan 20-30, NL-4462 EP Goes  
The Netherlands  
T. +31 113 23 89 11  
F. +31 113 23 20 03  
[www.timesaversint.com](http://www.timesaversint.com)

**TIMESAVERSINT.COM**

